

# Gain energy insight and control with PowerLogic™

PowerLogic ION7550/ION7650

power and energy meters

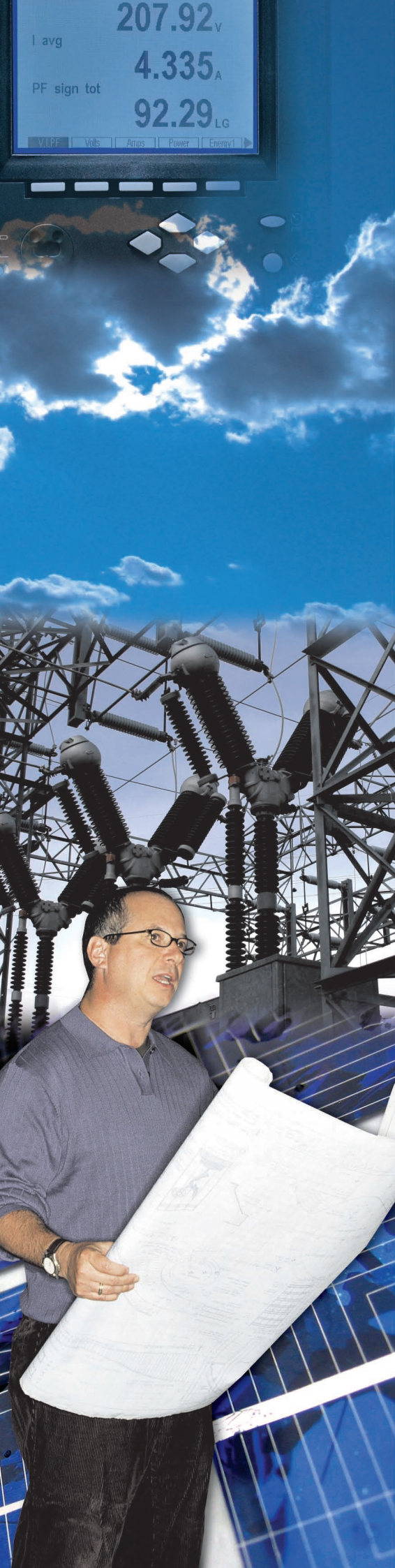



## Intelligent metering and control devices

Used at key distribution points and sensitive loads, the Schneider Electric PowerLogic ION7550 and ON7650 meters offer unmatched functionality including advanced power quality analysis coupled with revenue accuracy, multiple communications options, web compatibility, and control capabilities.

Integrate these meters with our PowerLogic ION Enterprise software or share operations data with existing SCADA systems through multiple communication channels and protocols.

## Typical applications

### For infrastructure, industrials and buildings

- Energy savings
  - Measure efficiency, reveal opportunities and verify savings
  - Reduce peak demand surcharges
  - Reduce power factor penalties
  - Strengthen rate negotiation with energy suppliers
  - Enable participation in load curtailment programs (e.g. demand response)
  - Identify billing discrepancies
  - Leverage existing infrastructure capacity and avoid over-building
  - Support proactive maintenance to prolong asset life
- Energy availability and reliability
  - Validate that power quality complies with the energy contract
  - Verify the reliable operation of equipment
  - Improve response to power quality-related problems

### For electric utilities

- Energy availability and reliability
  - Improve T&D network reliability
  - Enhance substation automation to reduce field service time
  - Maximise the use of existing infrastructure
- Revenue metering and power quality
  - Install new high-accuracy metering at all interchange points
  - Improve or verify metering accuracy at existing interchange points
  - Verify compliance with new power quality standards
  - Analyse and isolate the source of power quality problems

# Features

## High visibility, multilingual, IEC/IEEE configurable display

Large, backlit LCD presents multiple simultaneous real-time and timestamped historical parameters as well as graphical trends and histograms. Multilingual support for English, French, Spanish and Russian. User-configurable IEC or IEEE notations. 12/24 hour clock support in multiple date/time formats.

## High accuracy standards

Meets stringent IEC and ANSI measurement accuracy standards such as IEC 62053-22 Class 0.2S, ANSI C12.20 0.2 Class 10 & 20.

## Digital fault recording

Simultaneously capture voltage and current channels for sub-cycle disturbance transients, as well as multi-cycle sags, swells and outages: 1024 samples/cycle waveform recording, 20/17  $\mu$ s transient capture (50/60 Hz).

## Power quality analysis and compliance monitoring

A choice of THD metering, individual current and voltage harmonics readings, waveform capture, EN50160 and IEC 61000-4-30 class A (ION7650 only) power quality compliance evaluation, and voltage and current disturbance (sag/swell) detection.

## Complete communications

Fiber - Ethernet - Serial - Modem. Gateway functionality simplifies communications architecture and reduces leased line or connection costs. Concurrent, independent ports communicate with protocols such as ION, DNP 3.0, Modbus RTU, Modbus TCP, Modbus Master. 32 concurrent Modbus/TCP server connections. Dial-out capability when memory is near full. Data push capability through SMTP (email).

## Patented ION technology

Provides a modular, flexible architecture that offers extensive user programmability. Uniquely addresses complex monitoring and control applications. Adapts to changing needs, avoiding obsolescence.

## Disturbance direction detection

Determine the location of a disturbance more quickly and accurately by determining the direction of the disturbance relative to the meter. Analysis results are captured in the event log, along with a timestamp and confidence level indicating level of certainty.

## Trending and forecasting

Forecast values such as demand to better control demand charges and billing rates. View results via the meter's web pages. Analyse trends to support proactive maintenance schedules.

## Transformer/line loss compensation

Automatically measure, compensate and correct for transformer or line losses when meter is physically separated from the point of billing or change of ownership.

## Inputs and outputs

Digital and analog inputs and outputs for pulse counting, demand metering for other WAGES utilities, equipment status/position monitoring, demand synchronisation, triggering conditional energy metering, equipment control or interfacing.

Integrated network comprising corporate intranet, Internet, serial, dialup or wireless connections

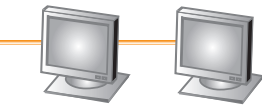

Financial management including accounting and billing

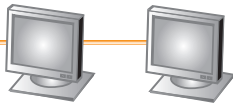

Facility and energy management

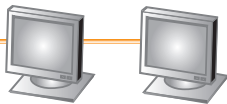

Operations management including engineering, planning and maintenance

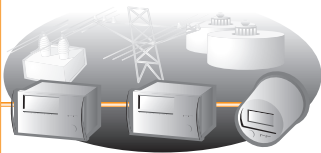

Power generation, transmission and distribution

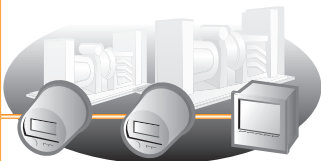

Service entrances and onsite generation

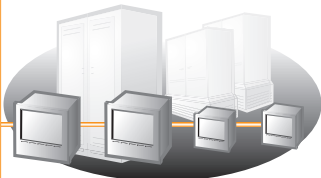

Power mitigation and main power distribution equipment

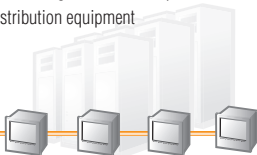

PDUs and data servers

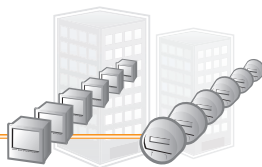

Tenants, departments or subcontractors

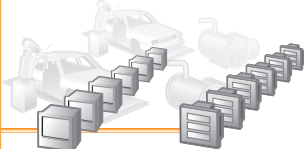

Processes, lines, machines or equipment

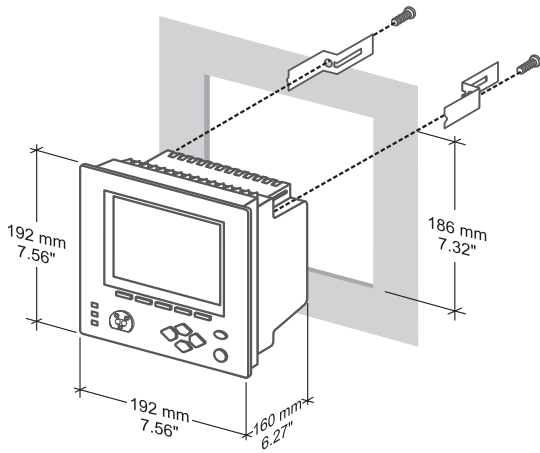

Meter installation showing rear mounting clips

## Installation

Designed to fit DIN standard 192 cutout (186 mm by 186 mm). Circuit and control power connections include 4-wire Wye, 3-wire Wye, 3-wire Delta, Direct Delta and single phase systems. Voltage inputs include 3 phase, one reference (neutral), and one auxiliary. Three current phase inputs are provided, as well as two auxiliary inputs for neutral and ground current measurement.

Input(s)	Specifications
<b>Voltage inputs</b>	
Nominal full scale:	347 direct V ac line-to-neutral, 600 V ac direct line-to-line, rms
Overload	1500 V ac rms continuous
Input impedance	5 M $\Omega$ per phase (phase-Vref)
Fault capture	1200 Vpeak
<b>Current inputs</b>	
Nominal current	5 A, 10 A, and/or 20 A (1 A, 2 A, 5 A optional current range)
Max voltage	600 V rms (CAT III IEC 61010-1)
Withstand	2500 V ac, 60 Hz for 1 minute
Load/burden	0.05 VA per phase (at 5 A standard) 0.015 VA per phase (at 1 A optional)
Impedance	0.002 $\Omega$ per phase (phase-Vref) 0.015 $\Omega$ (optional current range)
<b>Control power</b>	
Operating range	Standard: 85 to 240 V ac (+/-10%), 47 to 63 Hz; 110 to 300 V dc (+/-10%); burden: typical 15 VA, max 35 VA Optional: low voltage dc power supply; rated inputs: 20 to 60 V dc (+/- 10%); burden: typical 12 VA, max 18 VA
<b>Optional meter current probe inputs</b>	
Nominal input	1 V rms
Overload	5.5 V (CAT I IEC 61010-1)
Impedance	220 k $\Omega$ max.
Current probe options	Meter supplied with current probe inputs configured for use with standard 0-1 V ac current probes. Probes sold separately. Accuracy depends on probe specs  Meter supplied with current probe inputs and 3 calibrated Universal Technic 10A clamp-on CTs, meeting IEC 61036 accuracy

## Front panel

Use for both display and configuration purposes. The large backlit LCD display screen and the numerous selection, navigation, and configuration softkeys allow quick, secure access to basic meter configuration screens. The front panel also provides access to many other meter functions such as meter resets and has multiple programmable screens for numeric and time-stamped values, frequency spectrum (harmonics), trend logs, and name plate data.



The large display automatically scrolls through displays screens that present at-a-glance volts, amps, power, energy and demand values. Screens are easily customised to suit user requirements. The alphanumeric text displays are capable of supporting international labels such as OBIS and VDEW. Multilingual operation can be user-configured for English, French, Spanish or Russian. Set parameter measurements via front panel to comply with regional preferences. Modbus Master feature allows display of real-time parameters of any downstream modbus devices.

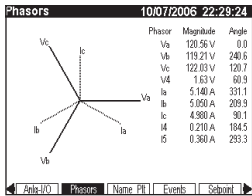

Phasors display

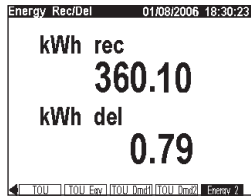

Energy received/delivered display

## Power and energy measurements

High-accuracy 4-quadrant energy metering in accordance with IEC 62053-22 class 0,2S for both 3- and 2-element systems. Real, bidirectional, reactive, and apparent values. Fully programmable integrating period (1, 5, 10, 15, 30, 60 minutes or other).

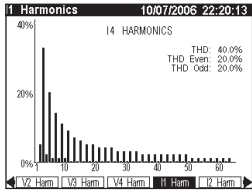

Harmonic current display

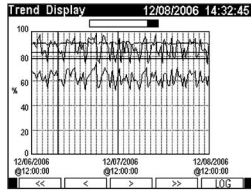

Trend display

Supports block, rolling block, and predicted demand calculations such as: kW, kvar and kVA demand, min/max; Volts and Amps demand, min/max; Cumulative demand; Demand on any instantaneous measurement.

Parameter	Accuracy 1 (%reading)
Voltage (line-line, line-neutral): per phase, min/max, unbalance	0.1%
Frequency: present, min/max	±0.005 Hz
Current (I1, I2, I3)	0.1%
Current (I4, I5)	0.4%
Power: real (kW), reactive (kvar), apparent (kVA), per-phase, total	IEC 62053-22 class 0,2S <sup>2</sup>
Power demand: kW, kvar, kVA	
Energy: real (kWh), reactive (kvarh), apparent (kVAh), rec/del	IEC 62053-22 class 0,2S <sup>2</sup>
Power Factor (at unity PF)	0.2%

<sup>1</sup> Refer to User's Manual for valid measurement ranges

<sup>2</sup> Refer to Compliance section. Not applicable for NICT meters, contact factory for measurement specifications

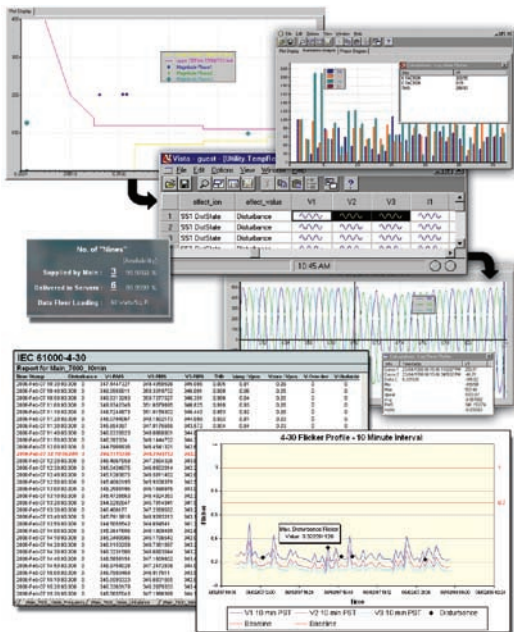

Example screen from PowerLogic ION Enterprise software showing continuous, wide-area monitoring, data capture and reporting for power quality and reliability conditions.

## Power quality

Power quality compliance monitoring for international quality-of-supply standards plus specific data for localized and custom compliance agreements and network connection requirements.

- Harmonics (all models): individual harmonics up to the 63<sup>rd</sup>, K factor and total harmonics distortion (THD).
- Sag/Swell (all models): voltage waveforms for sags and swells (i.e. ITI/CBEMA Type 2 and Type 3 disturbances); report on each disturbance's magnitude and duration. Detect sub-disturbances during a sag/swell event.
- Disturbance direction detection (all models): analyse disturbance information to determine the direction of the disturbance relative to the meter. Results are provided in the event log, along with timestamp and the level of certainty of disturbance direction.
- EN50160 (ION7650 with EN50160 ordering option only): monitor compliance with EN50160 parameters.
- IEC 61000-4-30 Class A (ION7650 only): monitor compliance of relevant parameters such as power frequency, magnitude of supply voltage, flicker, supply voltage sags and swells, transients and voltage interruptions. Create compliance reports using PowerLogic ION Enterprise software.
- Transient (ION7650 only): voltage waveforms of transient activity (i.e., ITI/CBEMA Type 1 disturbances).

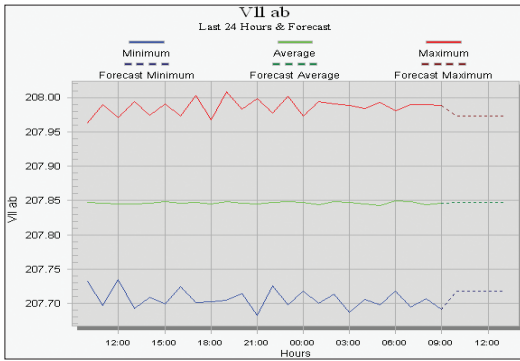

Trending and forecasting, as viewed from PowerLogic ION7650 web page.

	ION7550		ION7650	
	500 events	500 events	500 events	500 Events
Data <sup>A</sup>	1.5 years	3.1 years	1.3 years	2.9 years
Waveforms	180 <sup>B</sup>	180 <sup>B</sup>	360 <sup>C</sup>	360 <sup>C</sup>

A: 16 parameters recorded every 15 minutes

B: 30 waveforms on 6 channels at the maximum sampling rate

C: 30 waveforms on 12 channels with any selectable format (for example, 6 channels are 512 samples per cycle for 4 cycles, and 6 channels are 32 samples per cycle for 54 cycles)

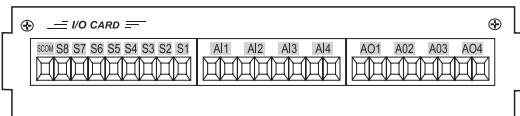

Top view of optional I/O card installed, showing connectors for digital inputs, analog inputs and analog outputs.

## Data and event logging

Ships with a comprehensive data-logging configuration. Data is prioritized and stored onboard in nonvolatile memory to eliminate data gaps in the event of outages or server downtime. Retrieved data is stored in an ODBC-compliant database when using PowerLogic ION Enterprise. Trending and forecasting capabilities track specified quantities over time and forecast the value of future quantities. View trending and forecasting data through the meter's web pages. Logging capacity is available in 5 MB or 10 MB configurations. Default depth and interval of logging is set at the factory and depends upon onboard memory size.

- Revenue log: configured for use with UTS MV-90 billing software. Logs kWh delivered interval, kWh received interval, kvarh delivered interval, kVARh received interval values.
- Historic logs: record standard power system quantities, such as phase current, phase voltage and power factor.
- Report Generator log: configured to provide power system data for PowerLogic ION Enterprise software.
- Event log
- Trend display logs

### Multiple tariffs and time-of-use (TOU) calculations

20-year calendar with automatic leap-year and seasonal time adjustments and clock synchronization over communications channel or GPS. TOU is configured four seasons, five daily profiles per season, four tariff periods per daily profile. Automatic mid-season rate change. Active, reactive, and apparent energy and demand; automatic recording of maximum (peak) demand during each tariff period.

## Inputs and outputs

All models provide digital inputs as well as Form C (mechanical relays) and Form A (solid state relays) digital outputs. Optional digital and analog I/O is also available.

Digital output relays respond to internal alarms, external digital input status changes, or commands over communications. Use digital inputs to trigger alarms or logging, synchronize to a demand pulse or control conditional energy accumulation.

Type	Input / output	Specifications
Electro-mechanical relays	3 Form C relays: R1 - R3 Form C contacts: NO, K, NC	250 V ac / 30 V dc, max. voltage: 380 V ac / 125 V dc. Turn-on time: 15 ms max; Turn-off time: 5 ms max. Update rate: 1/2-cycle or 1 second
Solid state relays	4 Form A digital outputs: D1-D4 <sup>1</sup>	Maximum voltage: 30 V dc; maximum current: 80 mA; isolation: optical; update rate: 1/2-cycle or 1 second
Analog (option)	4 inputs: AI1 to AI4	Signal type: dc current; range: 0 to 20 mA (scalable 4 to 20), or 0 to 1 mA; accuracy: +/- 0.3% of full scale; update rate: 1 second
	4 outputs: AO1 to AO4	Signal type: dc current; range: 0 to 20 mA (scalable 4 to 20) or -1 to 1 mA (scalable 0 to 1); update rate: 1/2 cycle or 1 second
Digital	8 inputs: S1 - S8	Self-excited (using SCOM output), dry contact sensing, no external voltage required. Min pulse width: 1 ms; max pulse rate: 20 pulses/sec. Timing resolution: 1 ms; update rate: 1/2 cycle (after timing resolution); isolation: 300 V peak; max rated voltage 120 V dc (external excitation)
	8 inputs (option): DI1 - DI8	Self excited (internal 30 V dc supply); dry contact sensing, or with external excitation 1.3 to 0.1 mm <sup>2</sup> (16 to 28 AWG); min pulse width: 20 ms; max pulse rate: 25 pulses per second; update rate: 1/2 cycle (after timing resolution)

### EtherGate and ModemGate

The meters can provide gateway functionality depending on communication options.

**EtherGate:** provides access from an Ethernet network (Modbus TCP protocol) to devices connected to the meter's serial ports (Modbus protocol).

**ModemGate:** provides access from the telephone network to devices connected to the meter's serial ports.

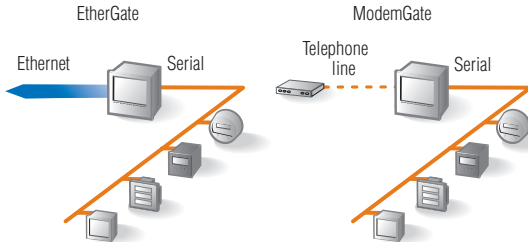

### Internet connectivity

Exchange information using XML to integrate with custom reporting, spreadsheets, databases and other applications.

**WebMeter:** an on-board web server, provides access to real-time values and PQ data through any web-enabled device and supports basic meter configuration tasks.

**MeterM@il:** automatically emails user-configured, high-priority alarm notifications or scheduled system-status update messages to anyone, anywhere within the facility or around the world.

## Communications

Multiple communication ports that operate simultaneously allow the meters to be used as part of a power and energy management system and to interface with other automation systems. Upload waveforms, alarms, billing data, and more to software for viewing and analysis.

Port	Specifications
Serial RS-232/RS-485 port (COM 1)	Protocols include ION, Modbus RTU, Modbus Master, DNP 3.0, GPS, EtherGate, ModemGate. Data rates: 300 to 115,200 bps. Duplex: Full (RS-232), Half (RS-485). Max length RS-232: 15.2 m (50 ft), RS-485: 1219 m (4000 ft) total for entire bus.
Serial RS-485 port (COM 2)	Protocols include ION, Modbus RTU, Modbus Master, DNP 3.0, GPS, EtherGate, ModemGate. Max length 1219 m (4000 ft) total for entire bus. Data rates: 300 to 115,200 bps. Duplex: Half
Internal modem (COM 3)	Data rates: 300 bps to 56 kbps (V.3.4, V.32 bis, V.32, V.22 bis, V.22 A/B, V.23, V.21, Bell 212A, Bell 103). Supports automatic data rate detection. RJ-11 interface. Approvals: FCC P68 (USA), Industry Canada CS-03. Also approved for use in: Austria, Belgium, Denmark, Finland, France, Germany, Greece, Iceland, Ireland, Italy, Luxembourg, Netherlands, Norway, Portugal, Spain, Sweden, Switzerland, UK.
ANSI C12.18 type II optical port (COM 4)	Protocols include ION, DNP 3.0, Modbus RTU. Data rates: 1200 to 19,200 bps. Duplex: half.
Ethernet port	Protocols: TCP/IP, DNP TCP, ION, Modbus TCP, Modbus RTU, SMTP, EtherGate. SNMP Interface: IEEE 802.3u-1995 and IEEE 802.3x-1997, ISO/IEC 8802-3:1993 (Ethernet). 10BASE-T, 100BASE-TX: connectors: RJ-45, cabling: Category 5 or 6 unshielded twisted pair, max. length 100 meters (328 feet). Isolation: Transformer isolated to 1500 volts RMS. Data rates: 10/100 Mbps. Duplex: full/half. 100BASE-FX (fibre): connectors: SC; cabling: 62.5/125 or 50/125 micrometer multimode fibre optic. Max. length 2000 m (6562 ft) full duplex, 400 m (1312 ft) half duplex. Data rates: 100 Mbps.

## Software integration

Integrate within PowerLogic facility-level or enterprise-wide power and energy management systems. Real-time data and data logs stored onboard can be automatically retrieved on a scheduled basis for analysis at the system level. Compatible with PowerLogic ION Enterprise and PowerLogic ION Setup. Modbus compatibility and register-based logged data supports integration and data access by building automation, SCADA and other third-party systems.

## Special features

Flash-based firmware allows upgrades via communications without removing the meter from the site. Simply download the latest firmware from [www.powerlogic.com](http://www.powerlogic.com). Real time data, data logs and waveforms stored on board.

## General specifications

Description	Specifications
Safety/construction	IEC 1010-1 (EN61010-1); CSA C22.2 No 1010-1; UL 61010B-1 Electromagnetic Immunity; IEEE C.37-90.1-1989;EN50082-2
Dielectric withstand	2500 VAC RMS at 60 Hz for 60 s
Installation category	III (2000m above sea level)
Electromagnetic compatibility	IEC 61000-4-2 (EN61000-4-2/IEC 8012); IEC 61000-4-3 (EN61000-4-3/IEC 801-3) Radiated EM Field Immunity IEC 61000-4-4 (EN61000-4-4/IEC 801-4) Electric Fast Transient; IEC 61000-4-5 (EN61000-4-5/IEC 801-5) Surge Immunity IEC 61000-4-6 (EN61000-4-6/IEC 801-6) Conducted Immunity; IEC 61000-3-2 (EN61000-3-2); IEC 61000-3-3 (EN61000-3-3) FCC Part 15 Subpart B, Class A Digital Device; EN55011 (CISPR 11); EN55022 (CISPR 22); EN61000-6-4 (EN50081-2)
Environmental conditions	Operating temperature: -20° C to +70° C (-4° F to 158° F), no formation of ice Low Voltage DC Power Supply: -20° C to 50° C (-4° F to 122° F) Storage: -40° C to +85° C (-40° F to 185° F) Humidity: 5% to 95% non-condensing

Features	ION7550	ION7650
<b>Metering</b>		
Power, energy and demand	■	■
<b>Power quality</b>		
Sag/swell, harmonics monitoring	■	■
Harmonics: individual, even, odd, up to	63rd	63rd
Harmonics: magnitude, phase and inter-harmonics		50th
Symmetrical components: zero, positive, negative	■	■
Recording compliant with IEC 61000-4-30 Class A		■
IEC61000-4-15 flicker		■
EN50160 compliance checking		■
Transient detection, microseconds (20µs for 50Hz, 17µs for 60Hz)		20/17
Sampling rate, maximum samples per cycle	256	1024
Disturbance direction detection	■	■
<b>Logging and recording</b>		
Memory standard/optional	5 MB/10 MB	5 MB/10 MB
Min/max, historical, waveform logging	■	■
Timestamp resolution in seconds	0.001	0.001
Historical trend information via front panel display	■	■
GPS time synchronization	■	■
<b>Communications and I/O</b>		
RS-232/485; RS-485; Ethernet; Optical	■	■
Internal modem	1	1
3-port DNP 3.0 via serial, modem, Ethernet, I/R ports	■	■
Modbus RTU slave/master; Modbus TCP	■	■
EtherGate, ModemGate, MeterM@il, WebMeter	■	■
Analog inputs/outputs (optional)	4/4	4/4
Digital status inputs/outputs	16/4	16/4
Relay outputs (standard)	3	3
<b>Setpoints, alarming, and control</b>		
Setpoints, number/minimum response time	65 <sup>1/2</sup> -cycle	65 <sup>1/2</sup> -cycle
Math, logic, trig, log, linearization formulas	■	■
Call-out on single & multi-condition alarms	■	■



"The 2007 award recognizes Schneider Electric for its technological advancements and wide product range in the field of power quality (PQ) and energy management solutions. In total, this is the fourth award that Schneider Electric and [recently acquired] Power Measurement have received from Frost & Sullivan in recognition of achievements in this arena." Prithvi Raj, Frost & Sullivan research analyst



Certificate No. 002188



Please contact your local sales representative for ordering information.

Visit [www.powerlogic.com](http://www.powerlogic.com) for more information on other PowerLogic products, applications and system solutions.

Schneider Electric  
35 Rue Joseph Monier  
CS 30323  
92506 Rueil Malmaison Cedex  
Tel : +33 (0)1 41 29 70 00  
[www.schneider-electric.com](http://www.schneider-electric.com) [www.powerlogic.com](http://www.powerlogic.com)

As standards, specifications and designs develop over time, always ask for confirmation of the information given in this publication. ION, ION Enterprise, Modbus, and PowerLogic are either trademarks or registered trademarks of Schneider Electric. All other trademarks are property of their respective owners.

Publishing: Schneider Electric Production: Schneider Electric PMC  
Printing: Imprimerie du Pont de Claix - made in France